

Fingerboard Geography for Violin

- First Position -

D Major

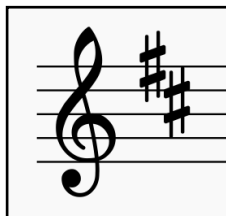

The key of D Major has 2 sharps: F# and C#.

Finger patterns used:

G string: _____ D string: _____

A string: _____ E string: _____

Finger patterns are 1-2, 2-3, 3-4, or open

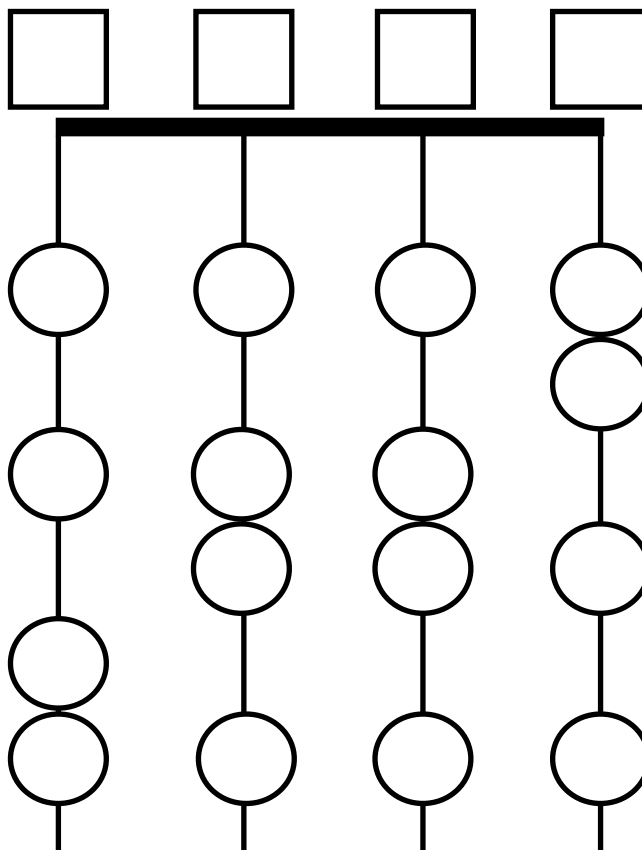

G Major

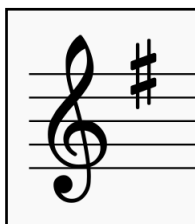

The key of G Major has 1 sharp: F#.

Finger patterns used:

G string: _____ D string: _____

A string: _____ E string: _____

Finger patterns are 1-2, 2-3, 3-4, or open

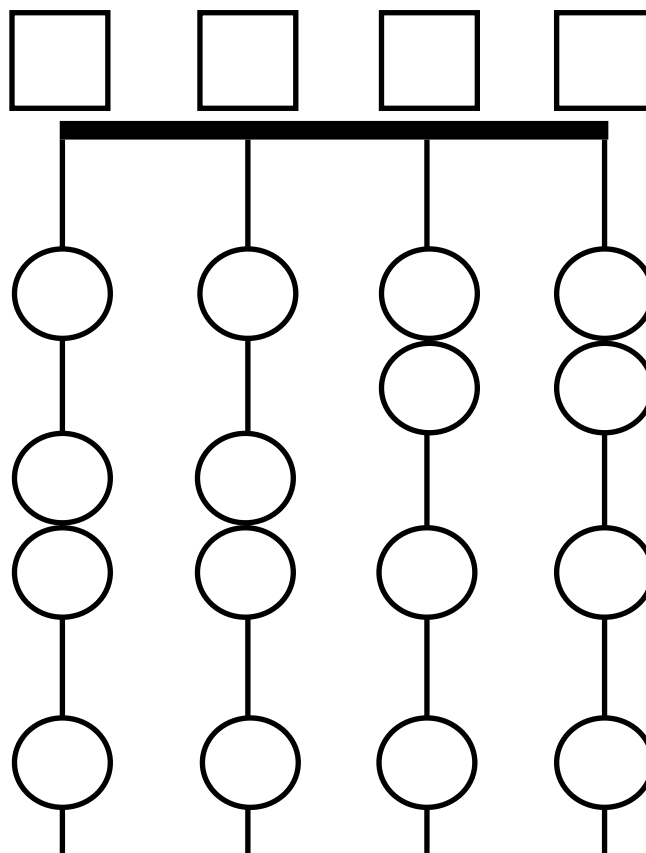

Fingerboard Geography for Violin

- First Position -

D Major

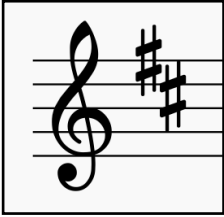

The key of D Major has 2 sharps: F# and C#.

Finger patterns used:

G string: 3-4 D string: 2-3

A string: 2-3 E string: 1-2

Finger patterns are 1-2, 2-3, 3-4, or open

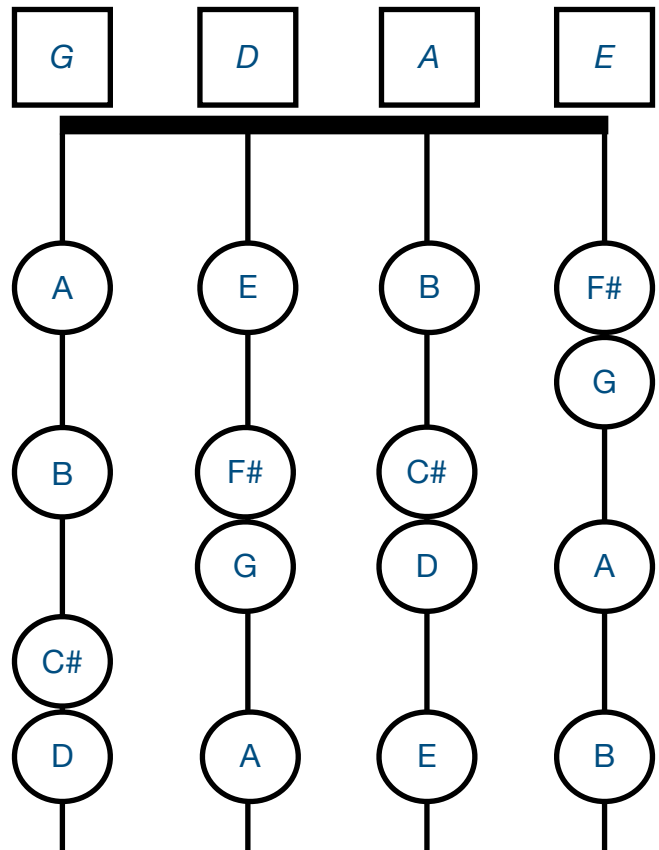

G Major



The key of G Major has 1 sharp: F#.

Finger patterns used:

G string: 2-3 D string: 2-3

A string: 1-2 E string: 1-2

Finger patterns are 1-2, 2-3, 3-4, or open

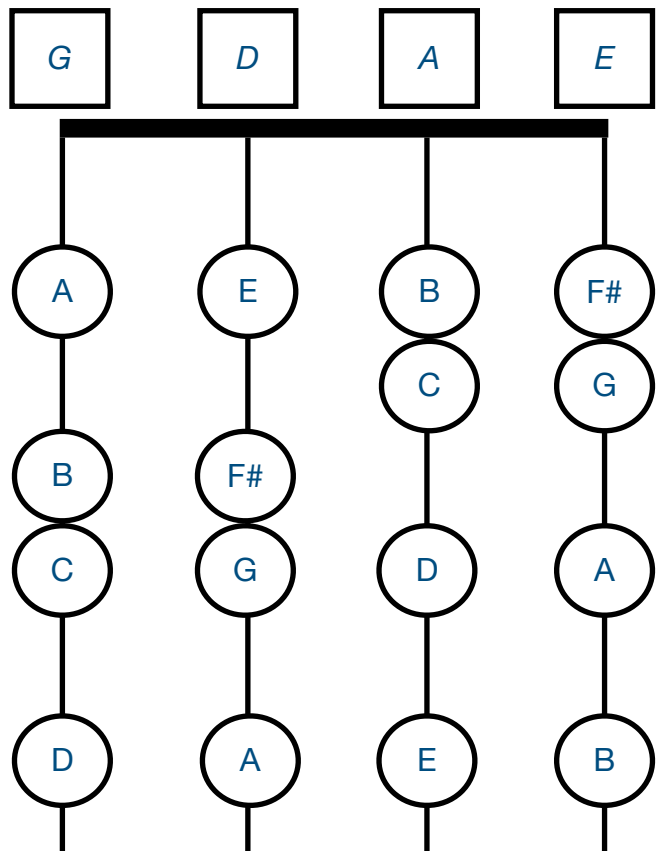

Fingerboard Geography for Violin

- First Position -

Key of C Major

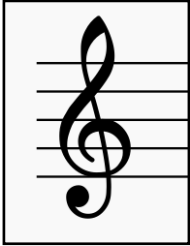

The key of C Major has no sharps or flats.

Finger patterns used:

G string: _____ D string: _____

A string: _____ E string: _____

Finger patterns are 1-2, 2-3, 3-4, or open

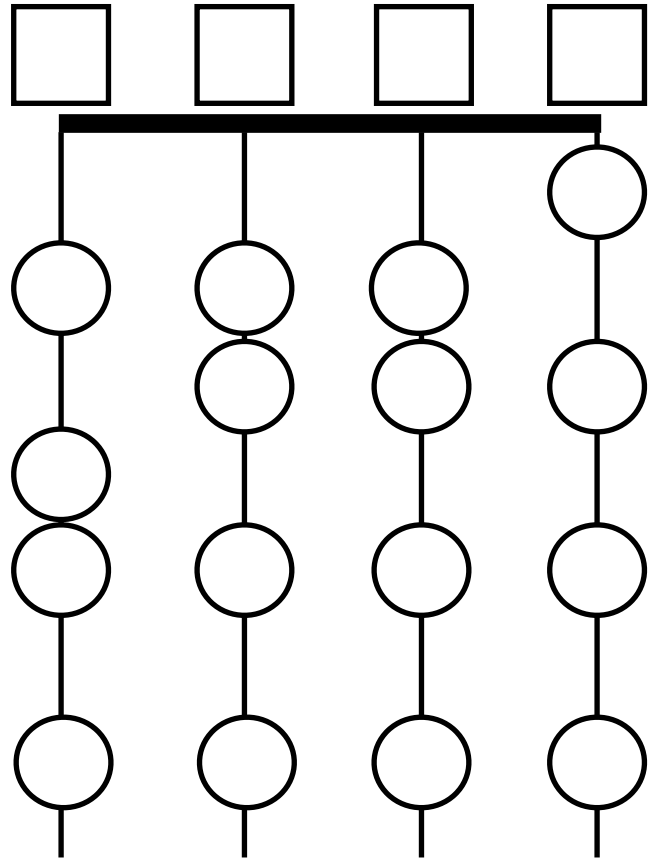

Key of F Major



The key of F Major has 1 flat, B-flat.

Finger patterns used:

G string: _____ D string: _____

A string: _____ E string: _____

Finger patterns are 1-2, 2-3, 3-4, or open

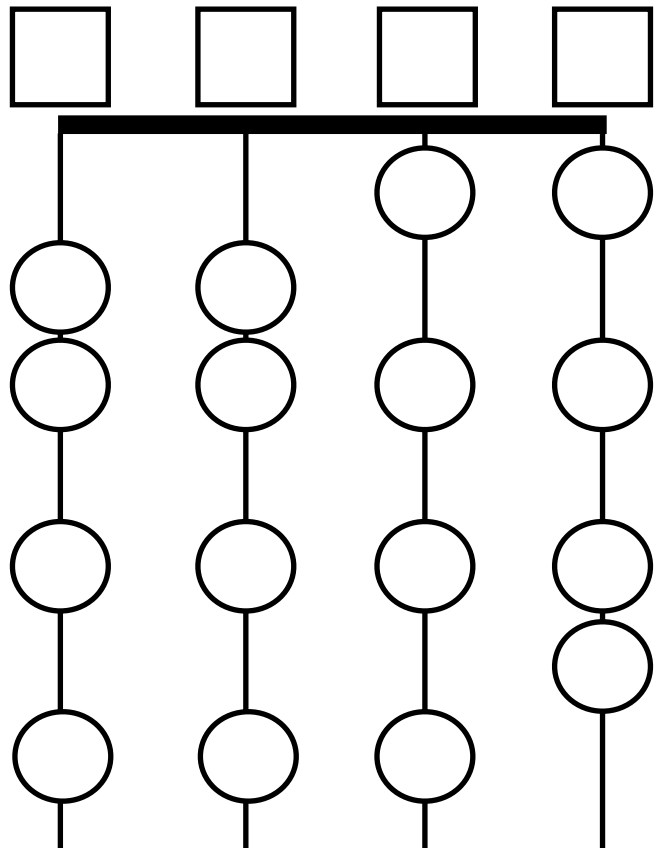

Fingerboard Geography for Violin

- First Position -

Key of B-Flat Major



The key of B-flat Major has 2 flats: B-flat and E-flat. (*Open E-string is not allowed!*)

Finger patterns used:

G string: _____ D string: _____

A string: _____ E string: _____

Finger patterns are 1-2, 2-3, 3-4, or open

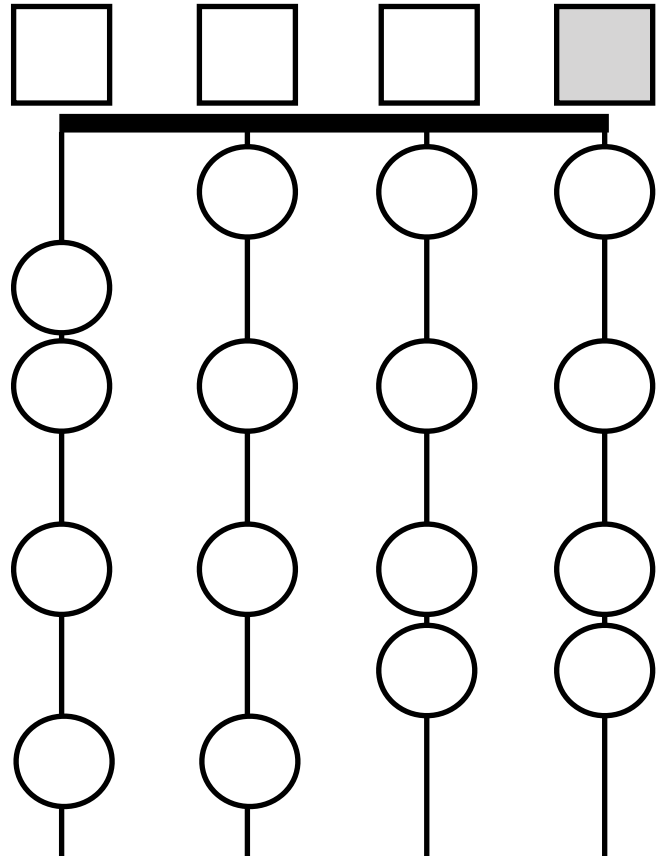

Key of A Major

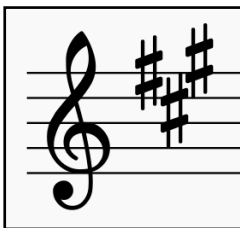

The key of A Major has 3 sharps: F#, C#, and G#.

Finger patterns used:

G string: _____ D string: _____

A string: _____ E string: _____

Finger patterns are 1-2, 2-3, 3-4, or open

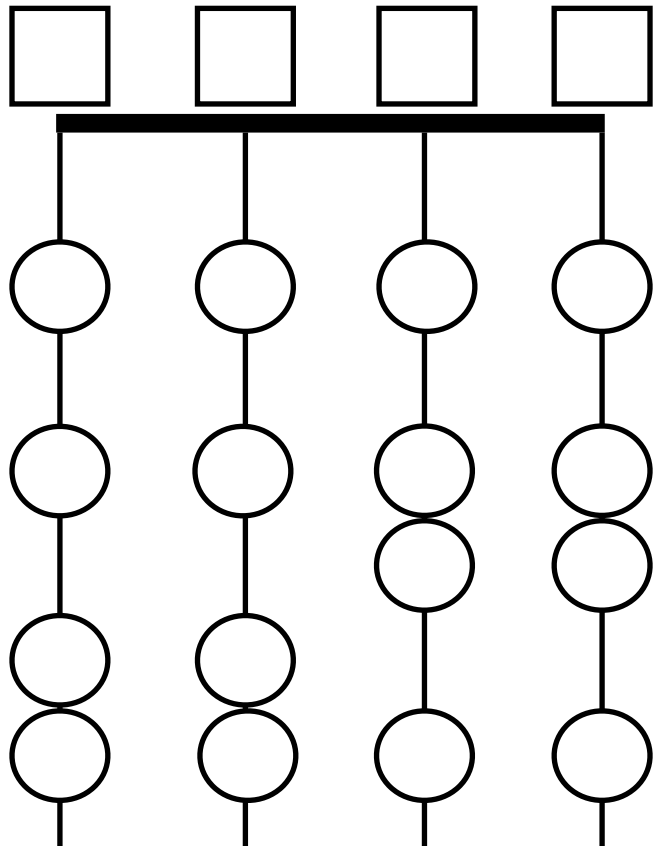

Fingerboard Geography for Violin

- First Position -

Key of E-flat Major

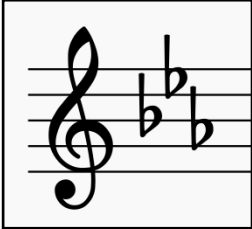

The key of E-flat Major has 3 flats: B-flat, E-flat, and A-flat. (Open E and A strings are not allowed!)

Finger patterns used:

G string: _____ D string: _____

A string: _____ E string: _____

Finger patterns are 1-2, 2-3, 3-4, or open

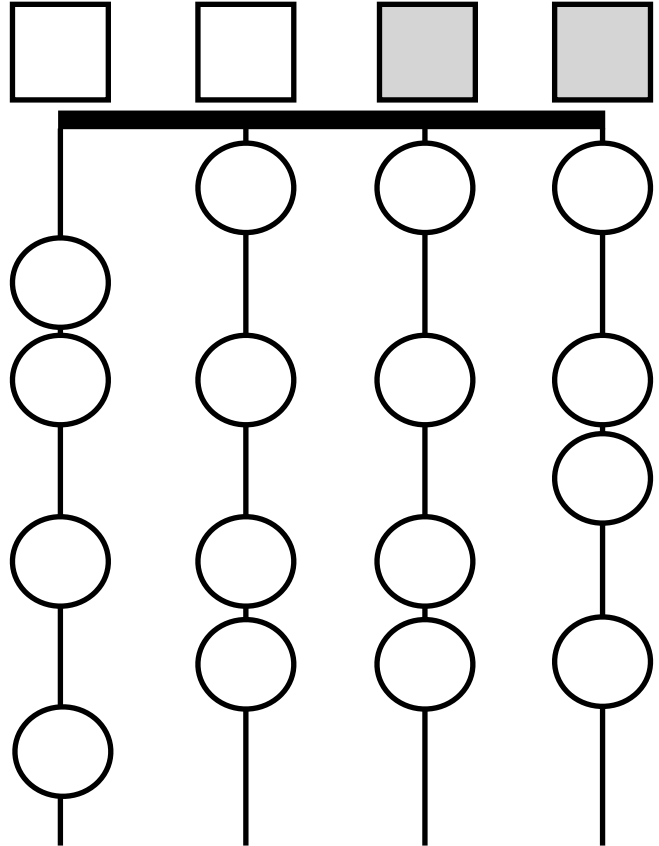

Key of E Major

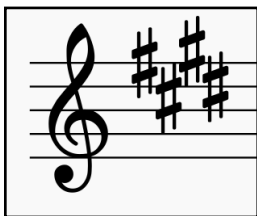

The key of E Major has 4 sharps: F#, C#, G#, and D#.

Finger patterns used:

G string: _____ D string: _____

A string: _____ E string: _____

Finger patterns are 1-2, 2-3, 3-4, or open

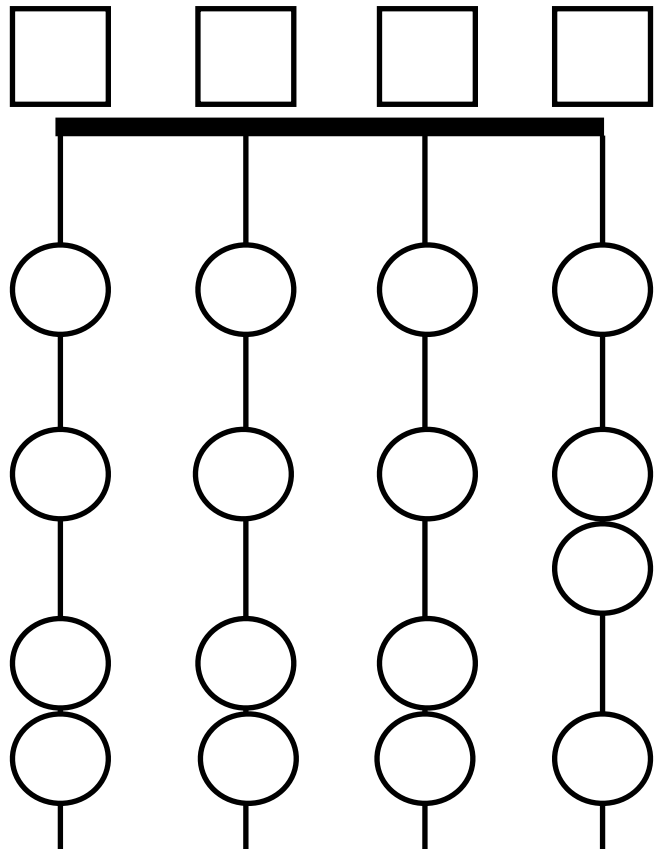

Fingerboard Geography for Violin

- First Position -

Key of A-Flat Major

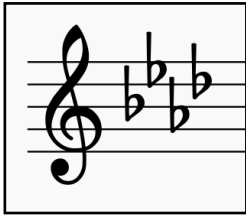

The key of A-flat Major has 4 flats: B-flat, E-flat, A-flat and D-flat. (Open E, A, and D strings are not allowed!)

Finger patterns used:

G string: _____ D string: _____

A string: _____ E string: _____

Finger patterns are 1-2, 2-3, 3-4, or open

Chromatics

Fill in ALL of the notes on your fingerboard, in half-steps.

Remember the natural half-steps: E-F and B-C.

